

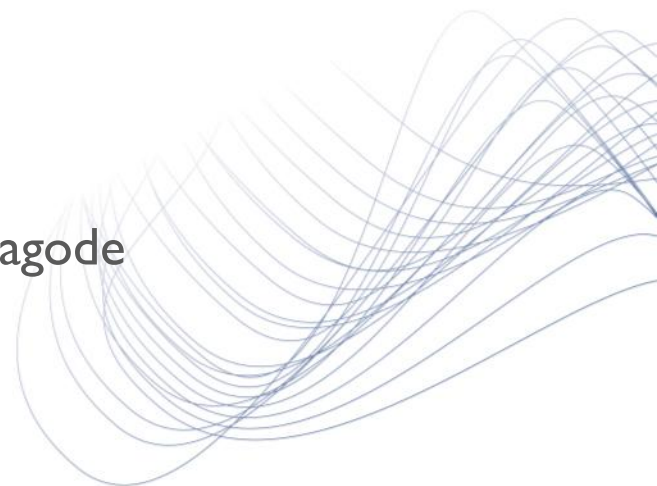

Strojni elementi 3

Valjaste zobniške dvojice

prof.dr. Marko Nagode





Shematski prikaz nastanka cikloid

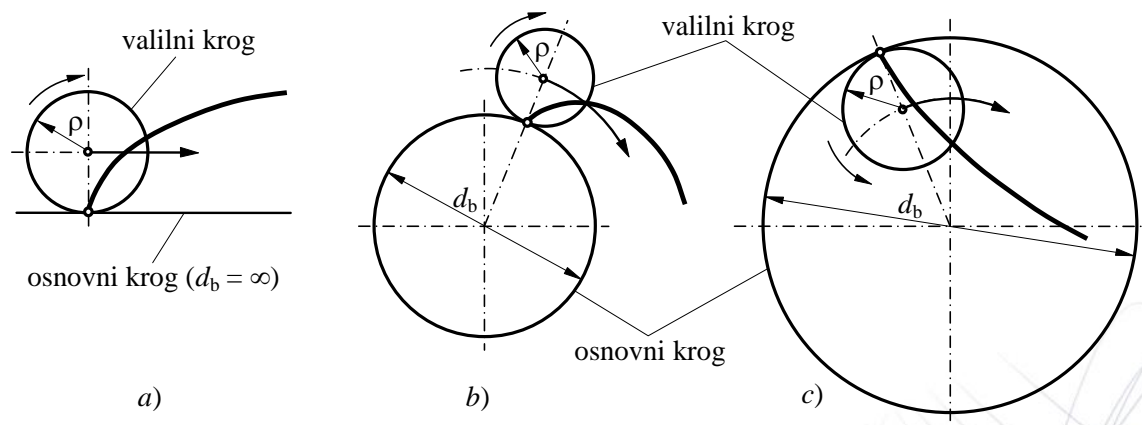



Zobniška dvojica s cikloidnim ozobjem

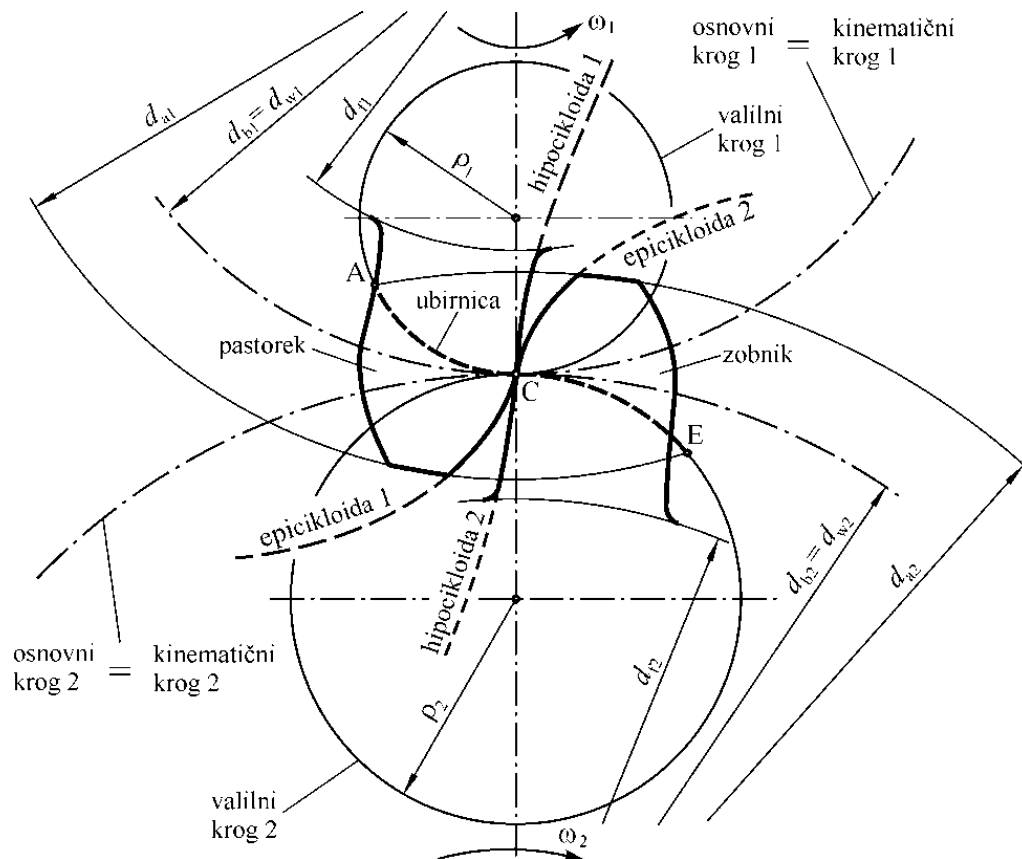



Primeri uporabe zobniških dvojic s cikloidnim ozobjem

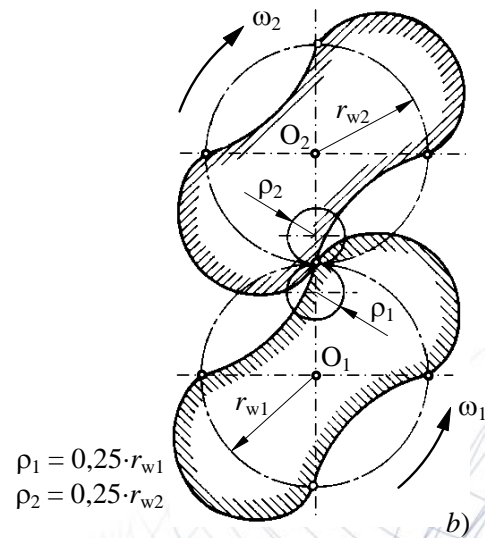
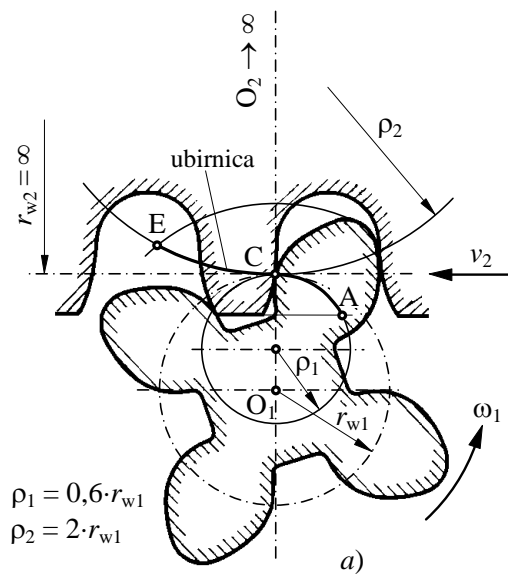



Osnovne veličine ravnnozobega valjastega zobnika

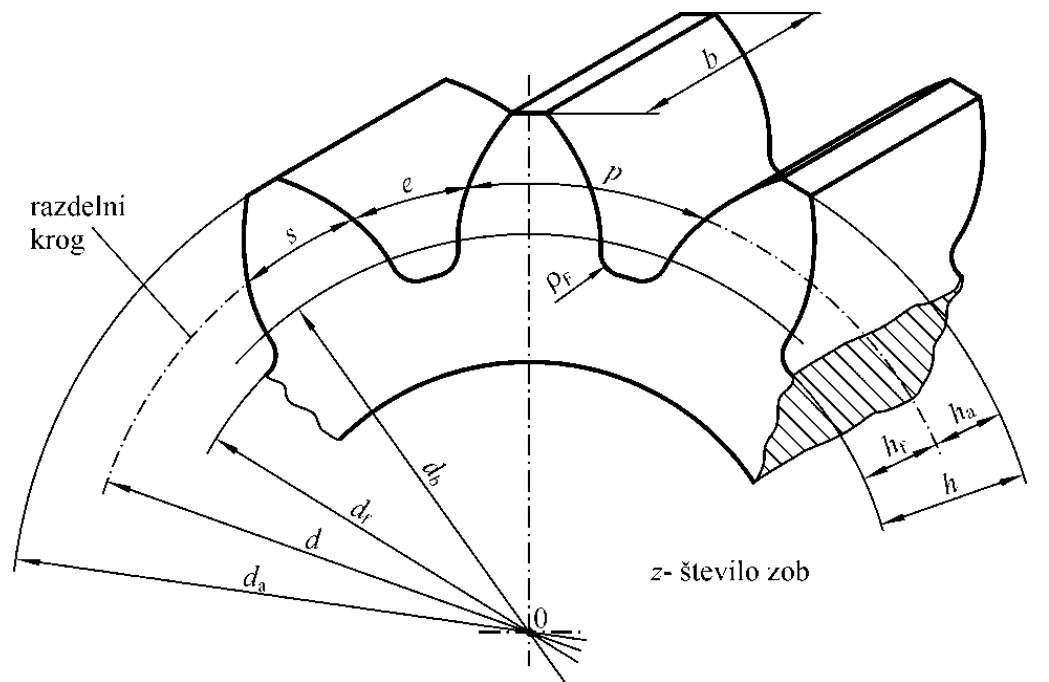

d_b premer osnovnega kroga
 d_r premer vznožnega kroga
 d premer razdelnega kroga
 d_a premer temenskega kroga

b širina zoba
 h višina zoba
 h_a višina zobnega vrha
 h_r višina zobnega korena

s debelina zoba
 e širina medzobne vrzeli
 p razdelek
 p_r zaokroženje v korenu zoba



Veličine za določitev evolvente (involutne) funkcije

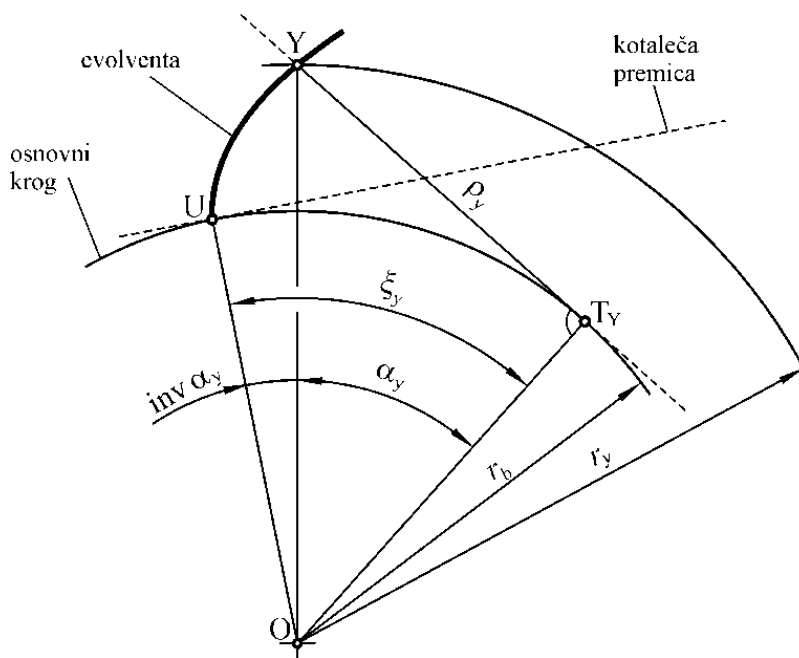



Ubiranje zobnih bokov pastorka in zobnika v poljubni ubirni točki Y

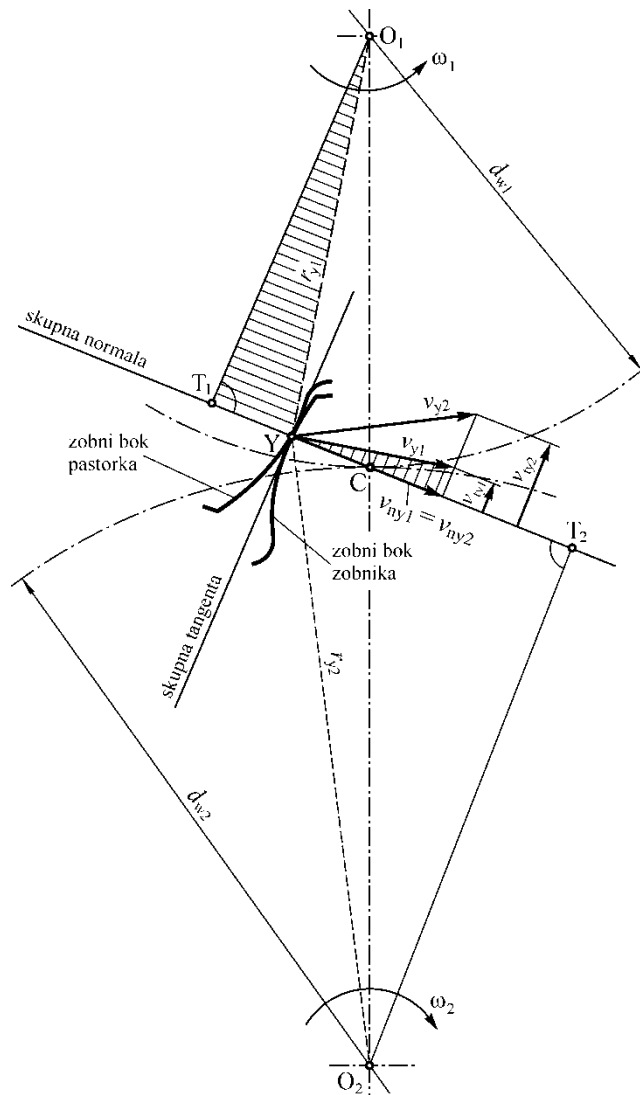



Osnovne veličine pri ubiranju valjaste zobniške dvojice z ravnim ozobjem

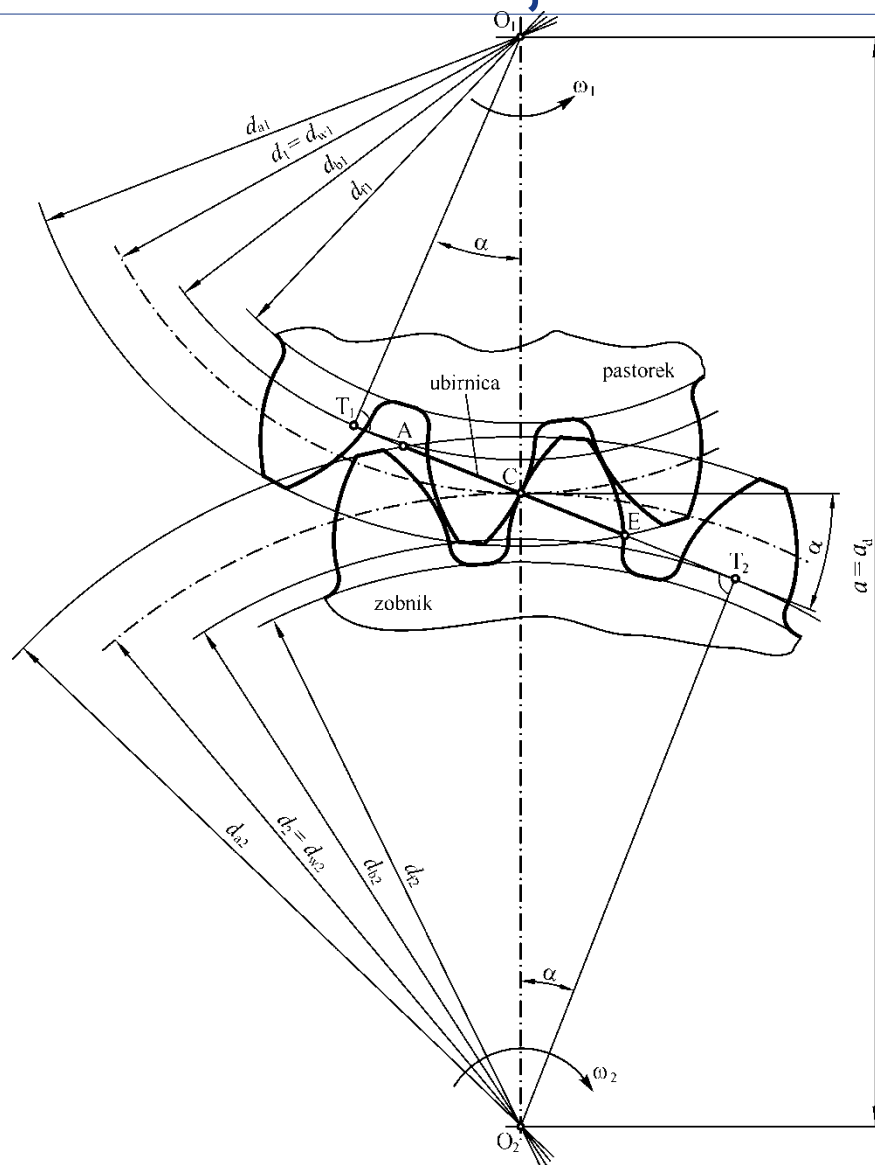



Valjasta zobniška dvojica z zobnico in osnovni profil zob zobnice po ISO 53 (DIN 867)

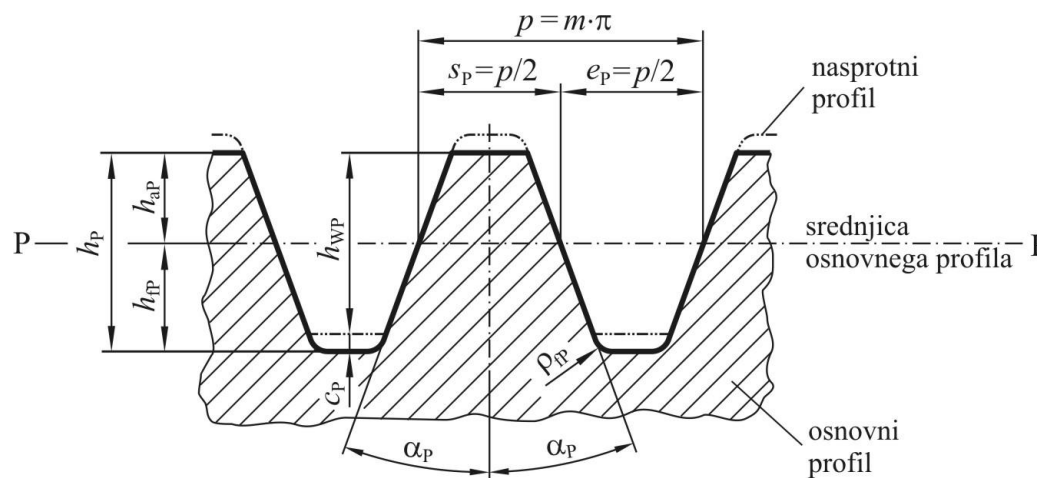
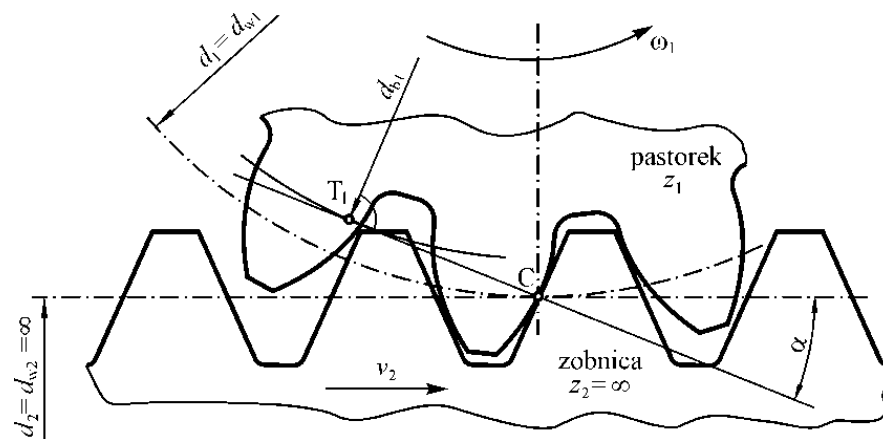



Profil orodja za zobčanje zobnikov po DIN 3960 in profil bočnice po zobčanju

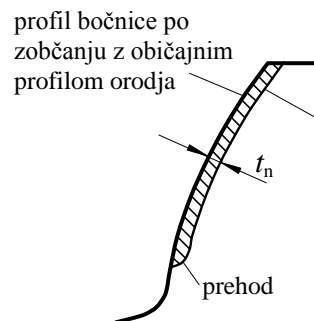
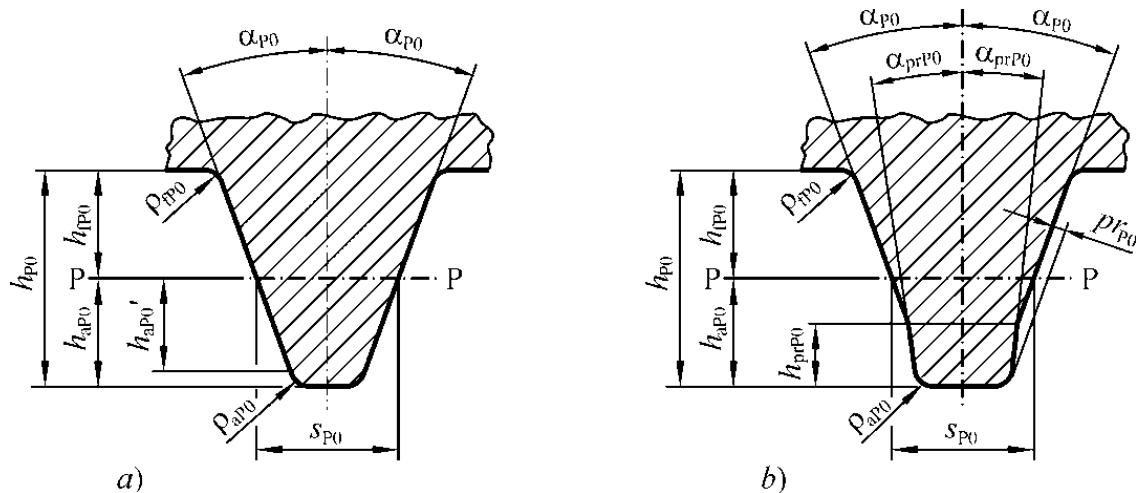

profil bočnice po
naknadni obdelavi
(npr. brušenju)

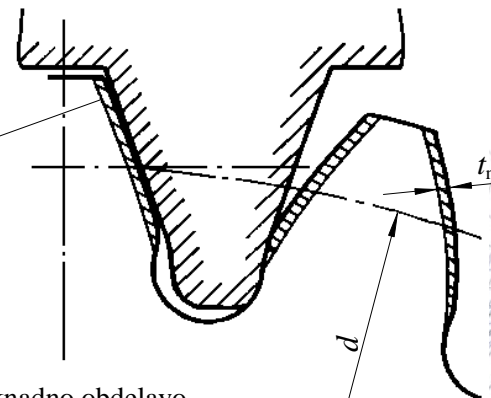

t_n dodatek za naknadno obdelavo

a)

b)



Nastanek notranjega zobnika

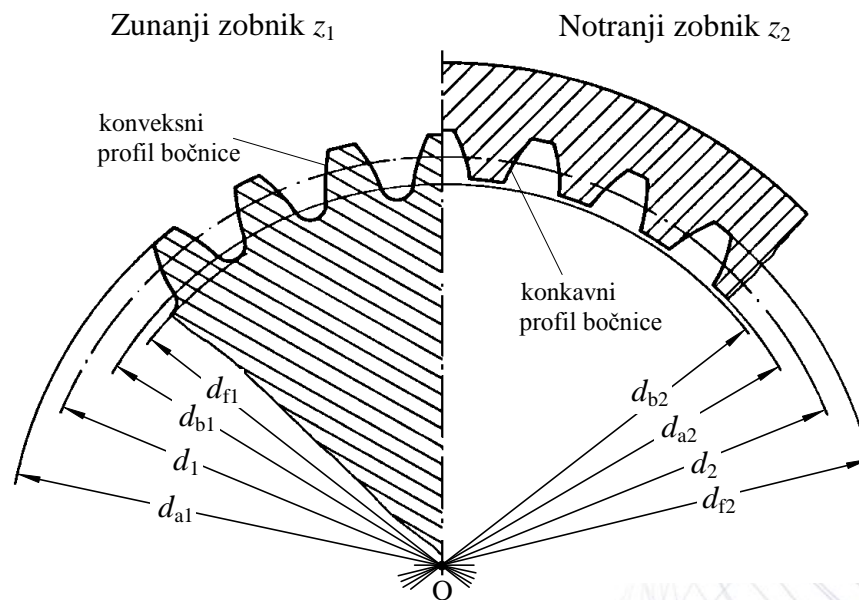



Zunanja valjasta zobniška dvojica s poševnim ozobjem in določitev smeri kota poševnosti zob

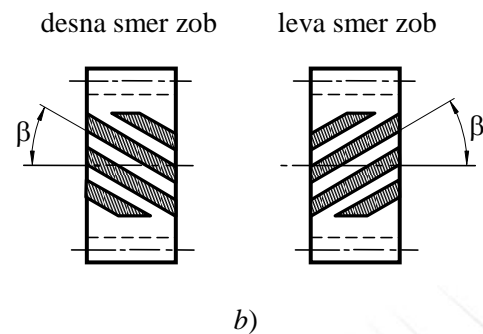
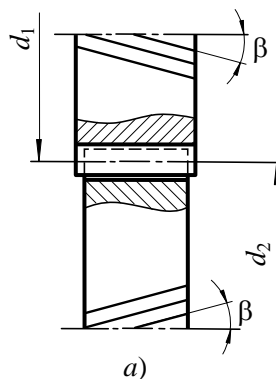



Radialni (T-T) in normalni (N-N) profil ozobnja poševnozobega zobnika

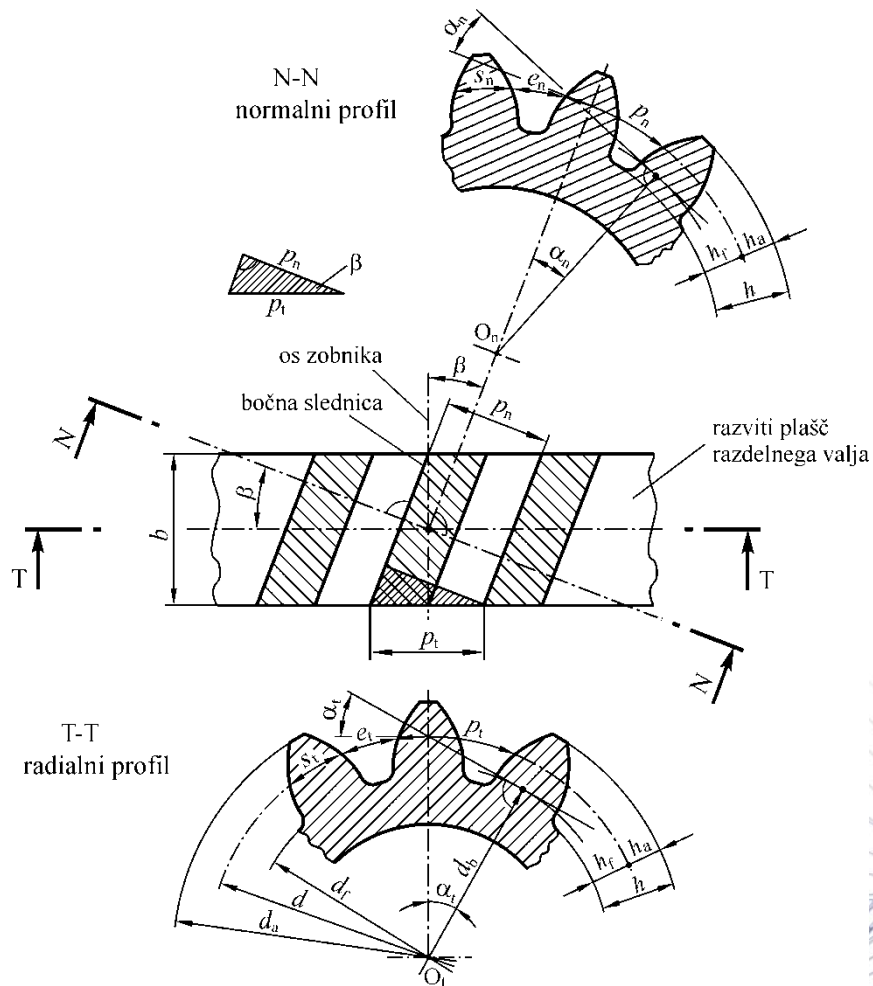



Radialni in normalni profil poševnozobe zobnice

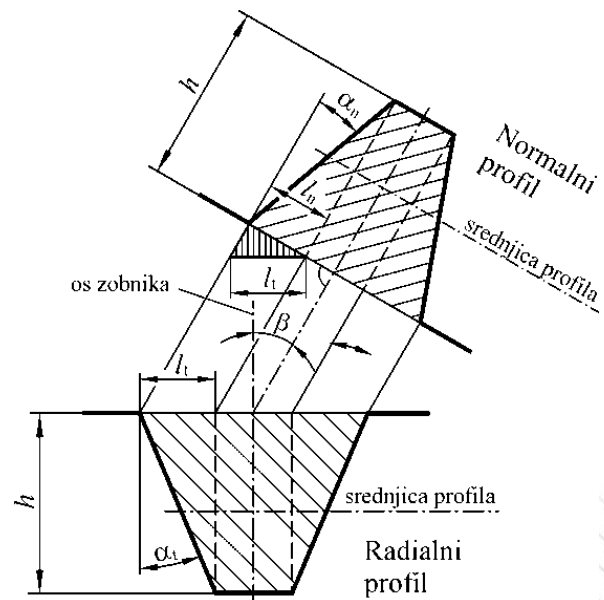
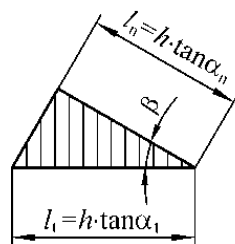



Nastanek nadomestnega valjastega zobnika

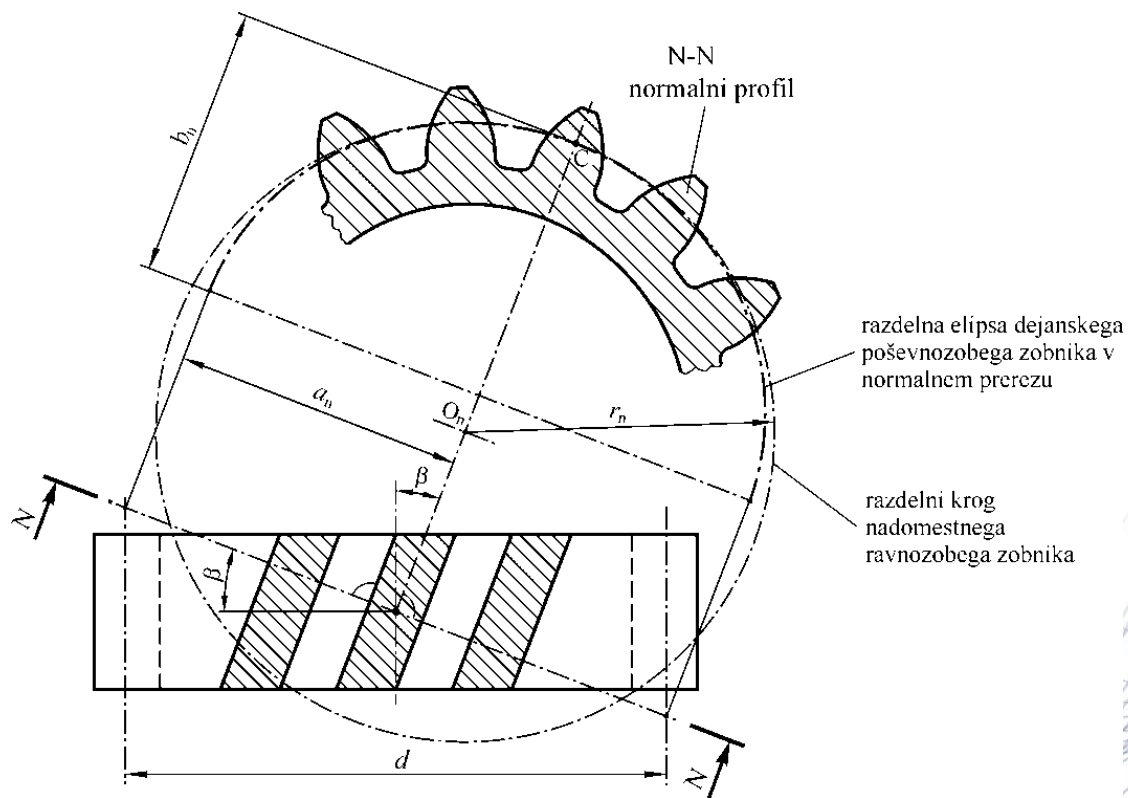



Odvalni postopek zobčanja zobnika z ravnim rezalnim grebenom

Ravni rezalni greben

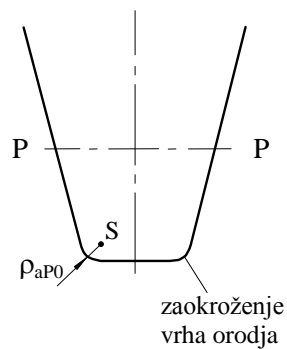

$z = 50$

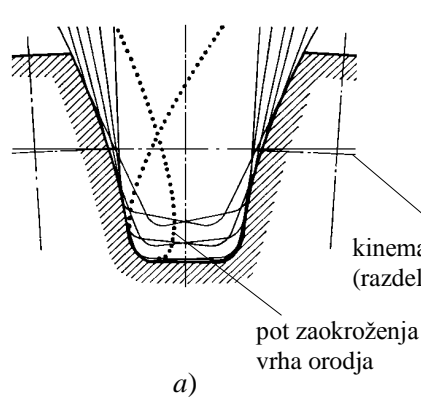

$z = 10$

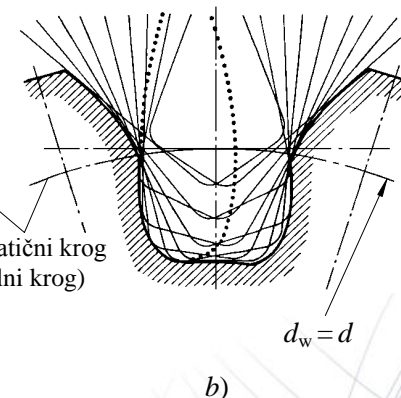



Veličine za določitev mejnega števila zob

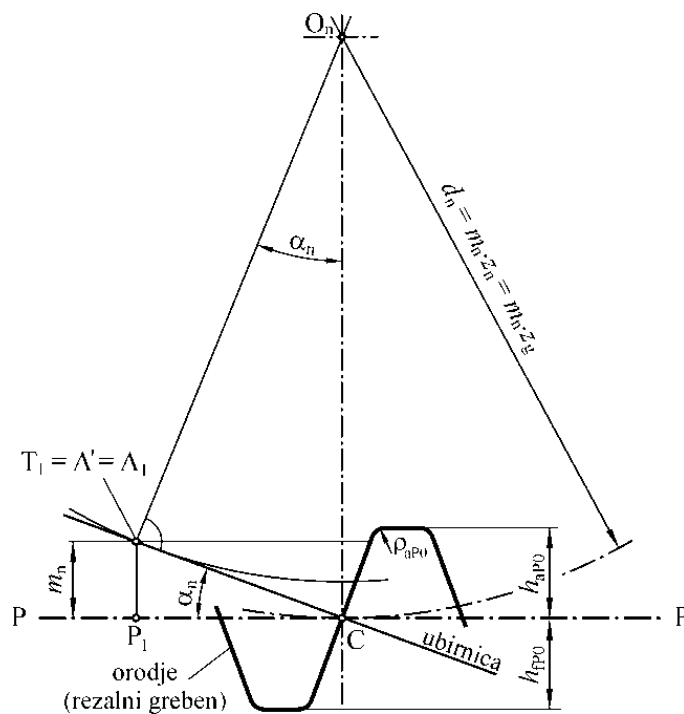



Premik profila osnovne zobnice

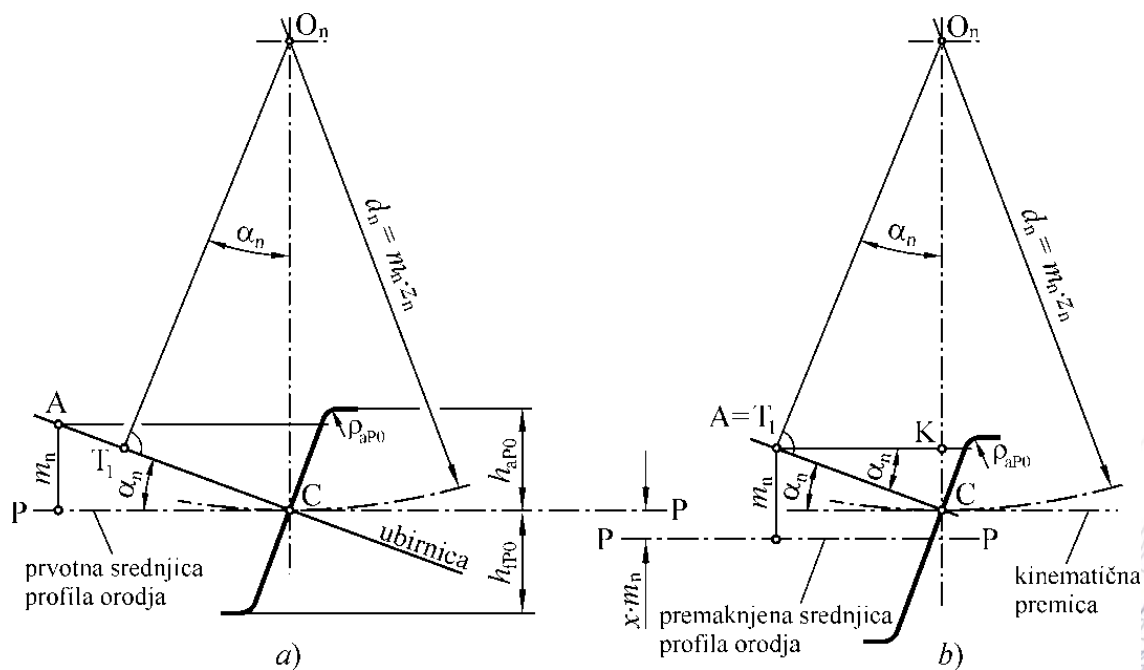



Oblika zob pri zunanjem zobniku z različnim profilnim premikom

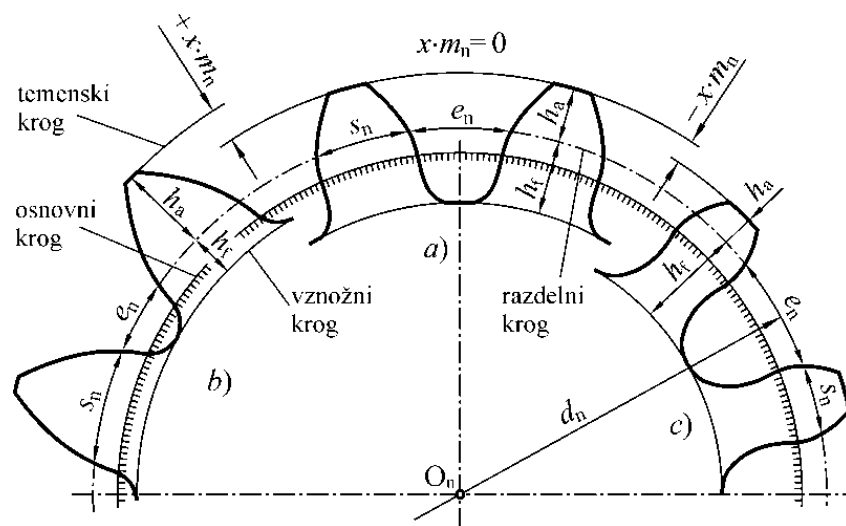



Zunanja zobniška dvojica z zobnico in profilnim premikom

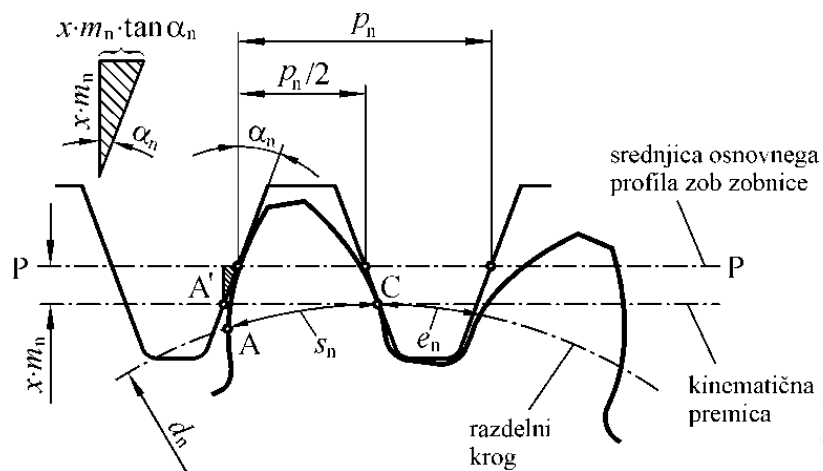



Radialna debelina zoba in radialna širina medzobne vrzeli

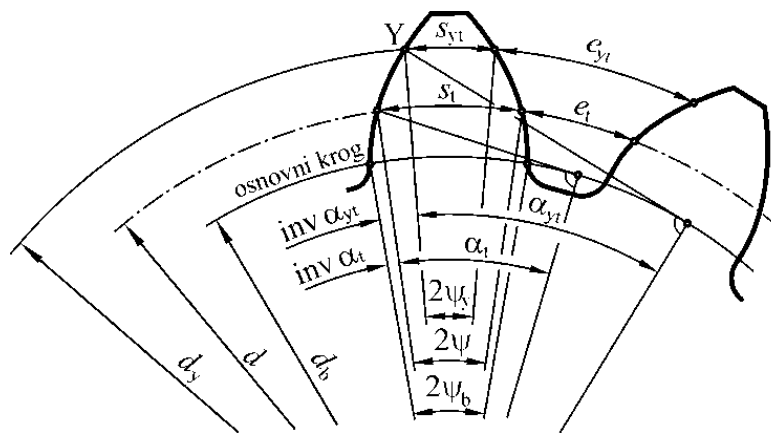



Višina zobnega korena in višina zobnega vrha

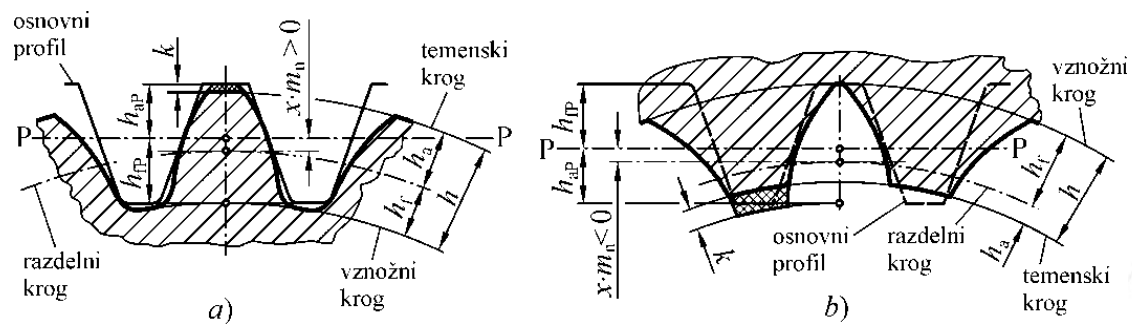



Premer vznožnega kroga in premer temenskega kroga

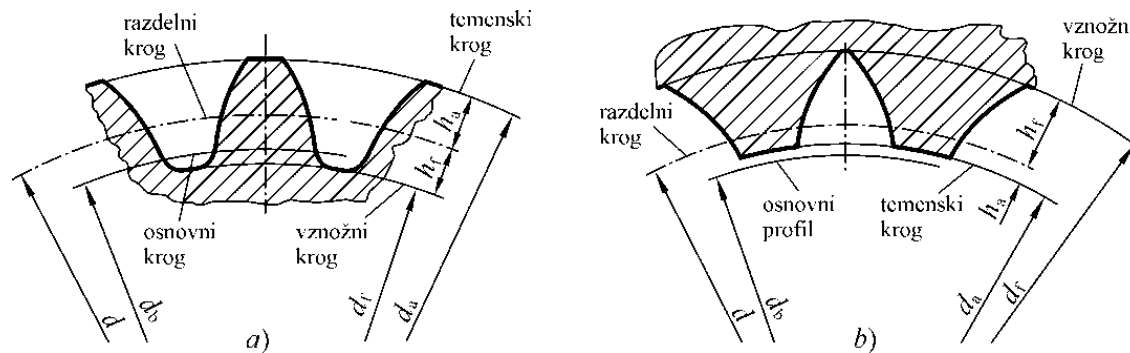



Normalna debelina zoba pri zunanjem zobniku in normalna širina medzobne vrzeli pri notranjem zobniku

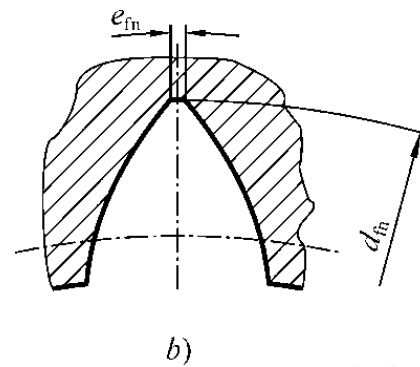
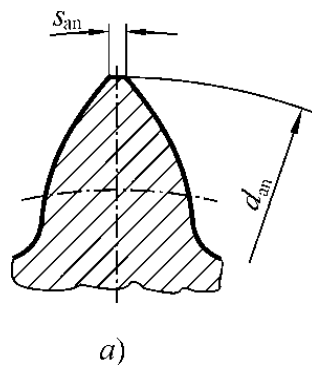



x-ničta valjasta zobniška dvojica

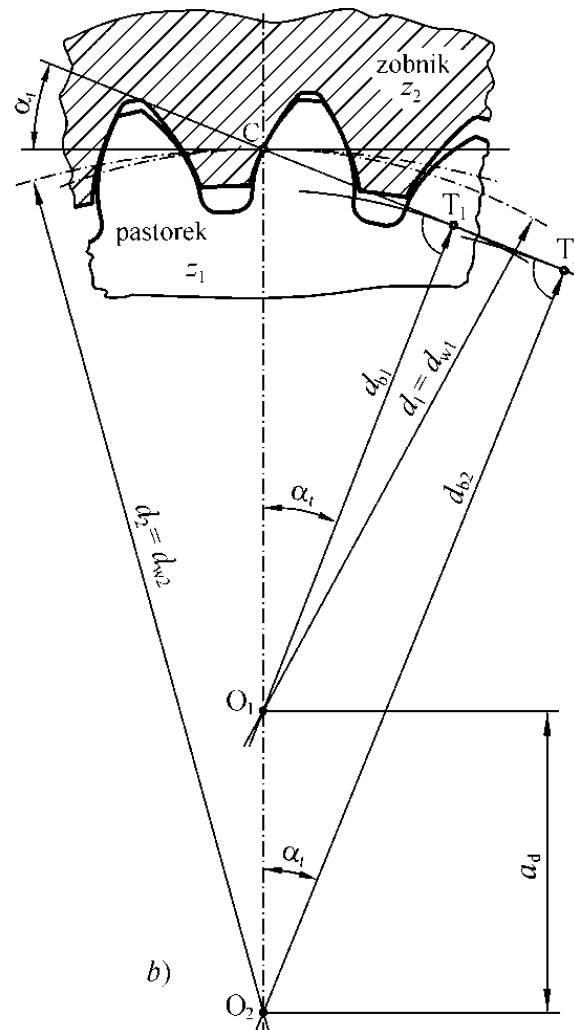
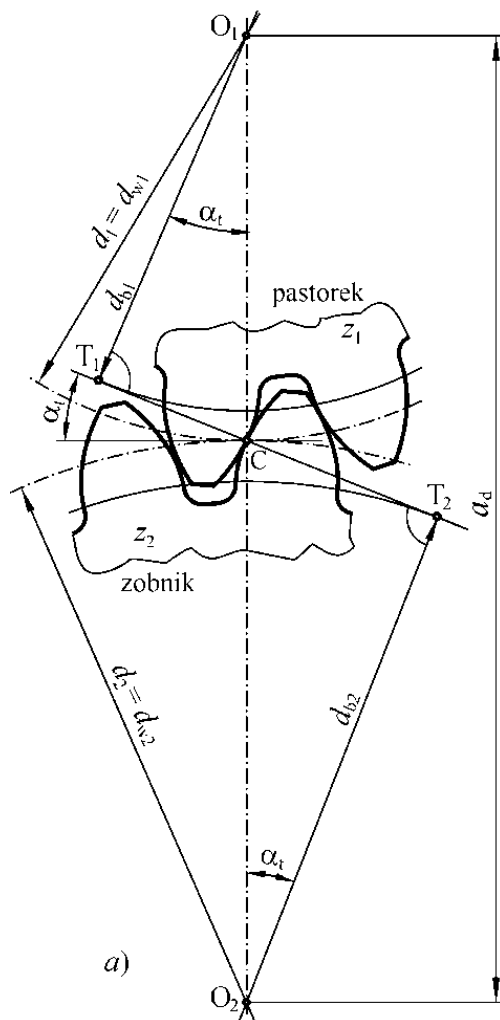



Določitev medosnega razmika x -te zobniške dvojice

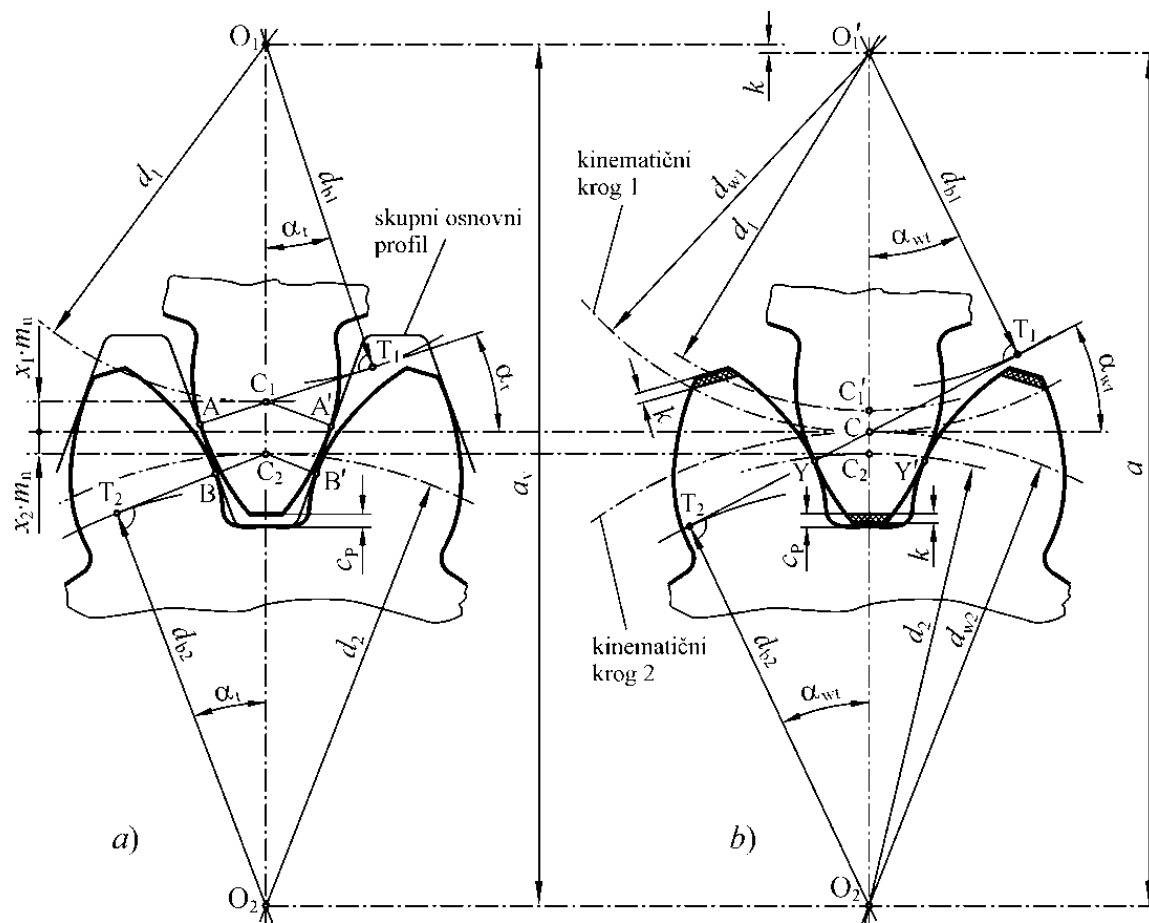



Debelina zoba, širina medzobne vrzeli in razdelek

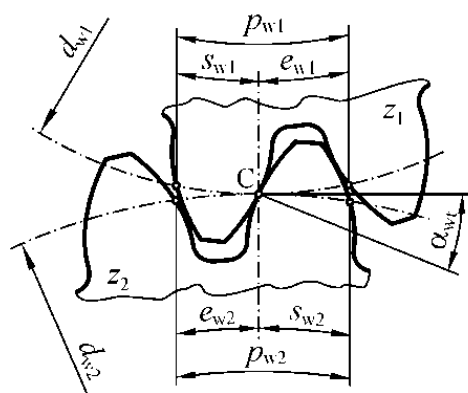

a)

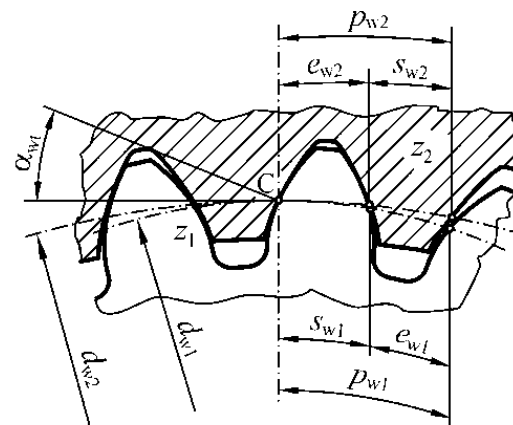

b)



Krožni, normalni in radialni bočni razstop

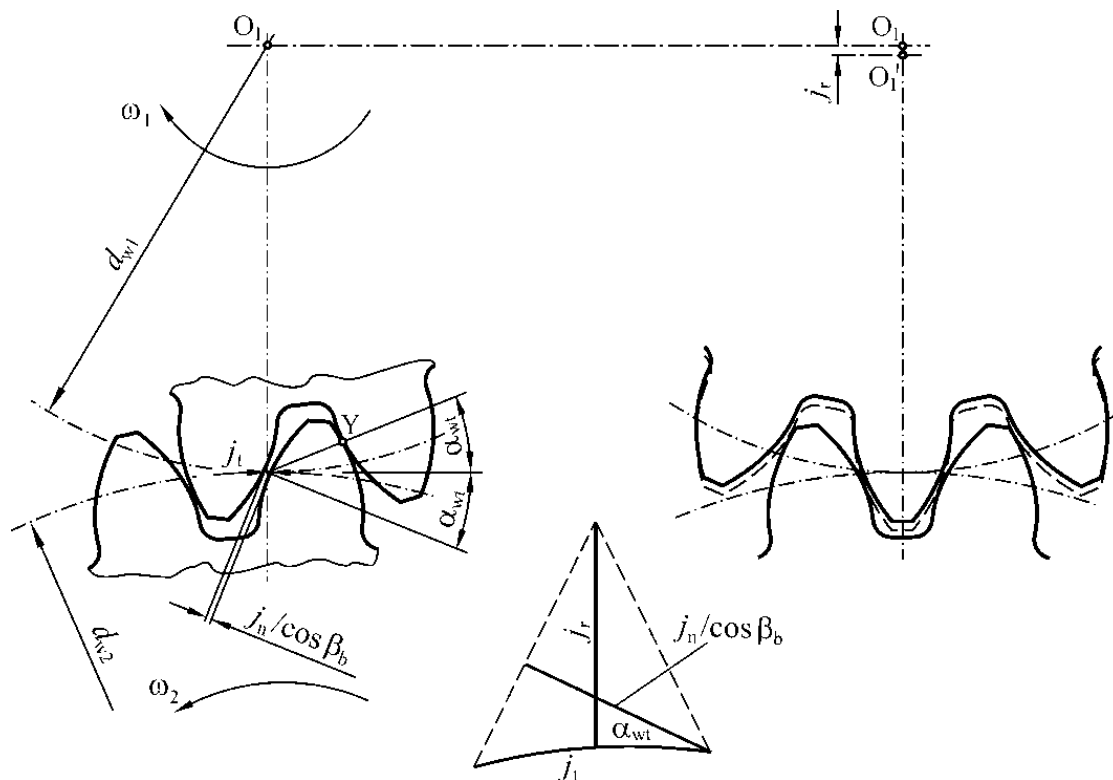



Dolžina ubirnice in ubirni razdelek

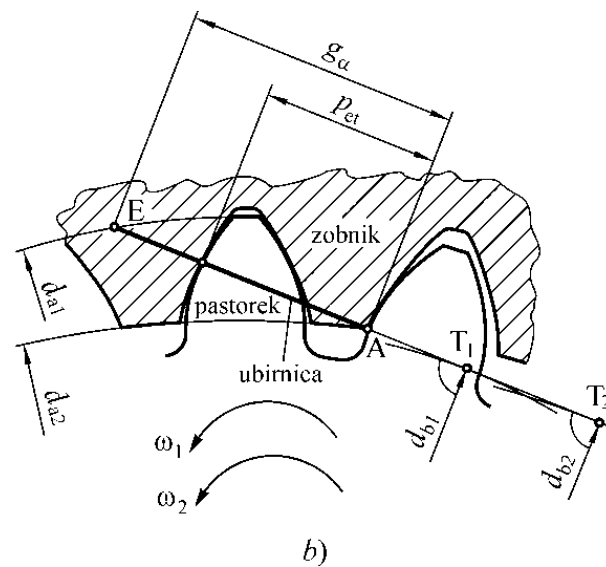
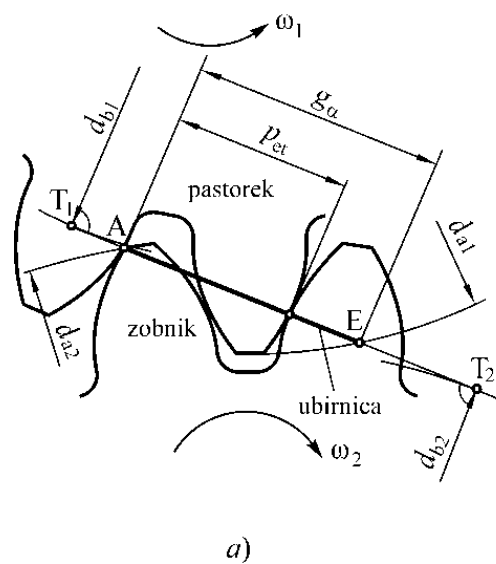



Geometrijske veličine za določitev dolžine ubirnice

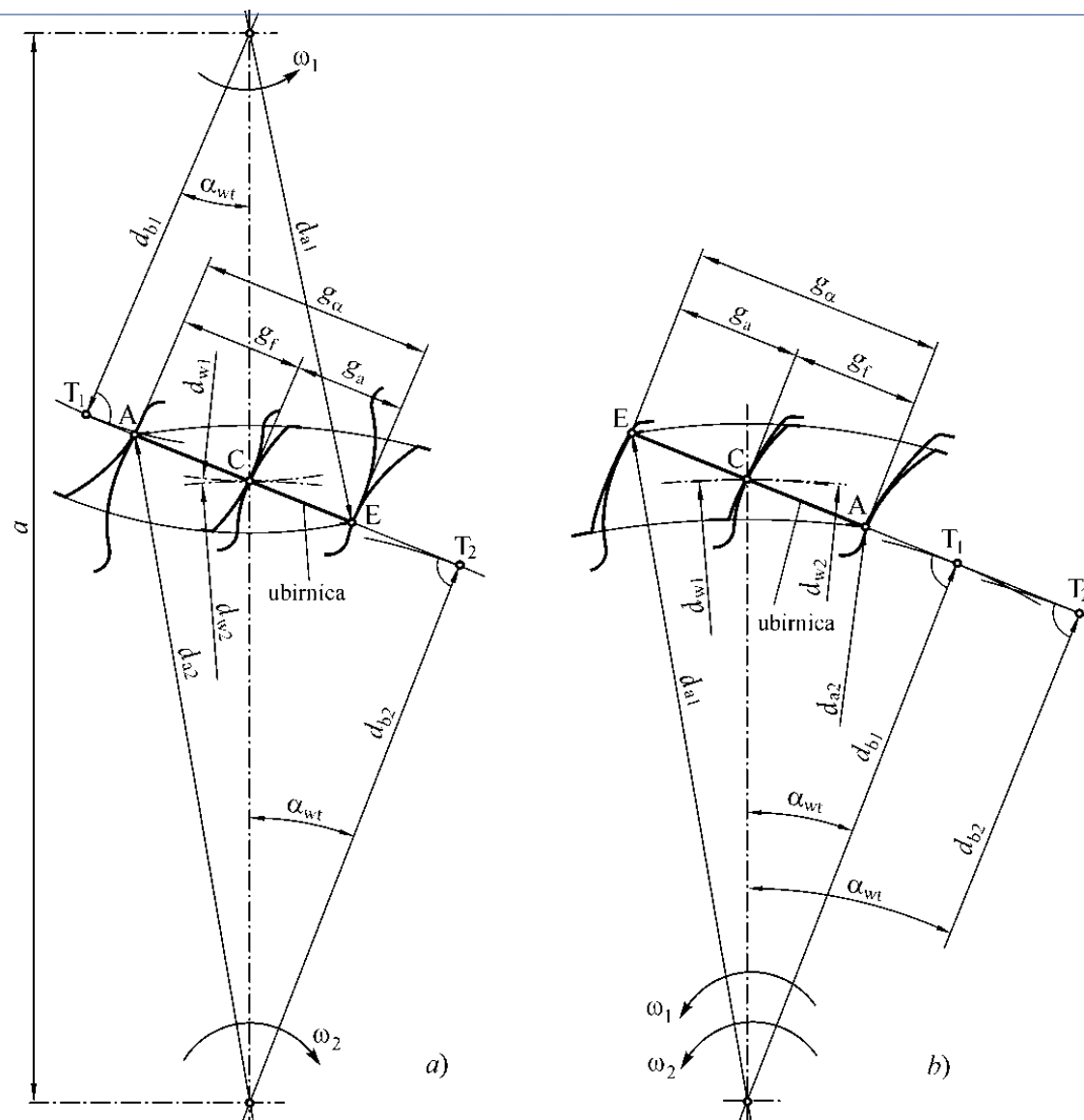

Vir: Flašker Glodež Ren Zobniška gonila



Ubirni razdelek in radialni razdelek na osnovnem krogu

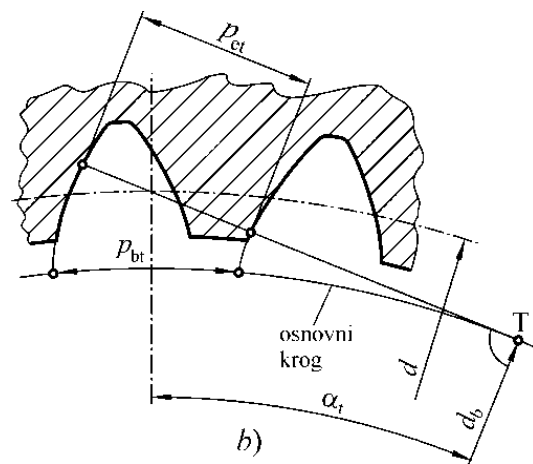
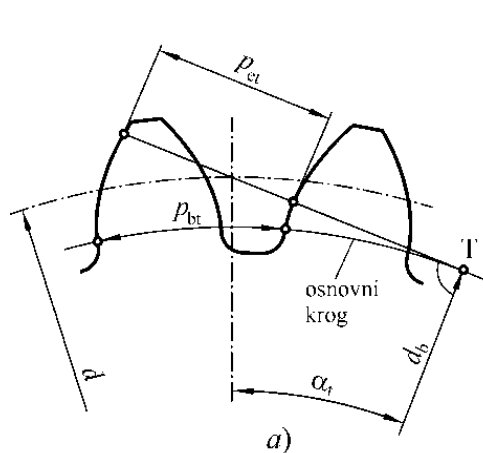



Ubiranje zunanje valjaste zobniške dvojice

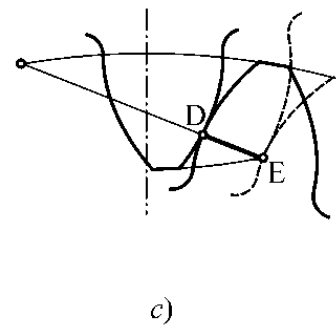
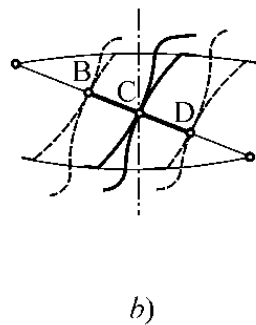
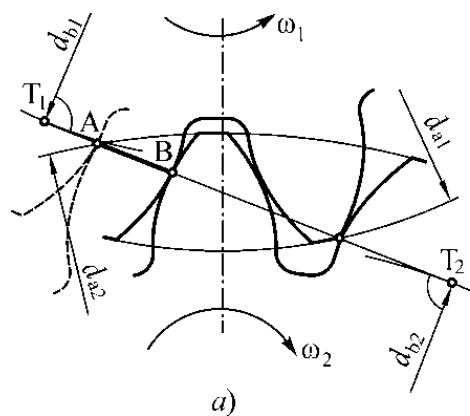



Shematski prikaz ubiranja poševnozobega zobnika

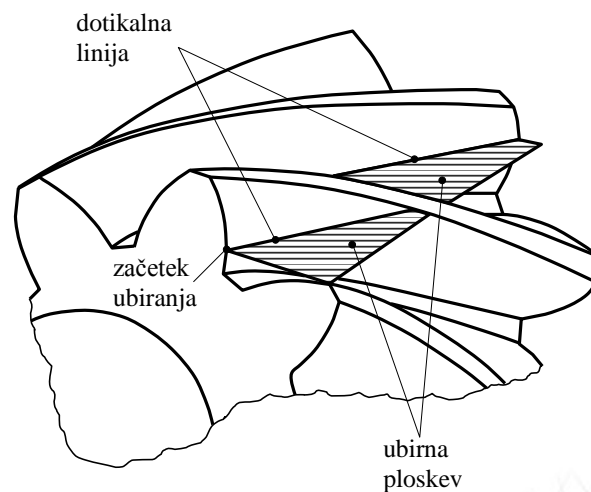



Osni razdelek pri poševnozobem valjastem zobniku

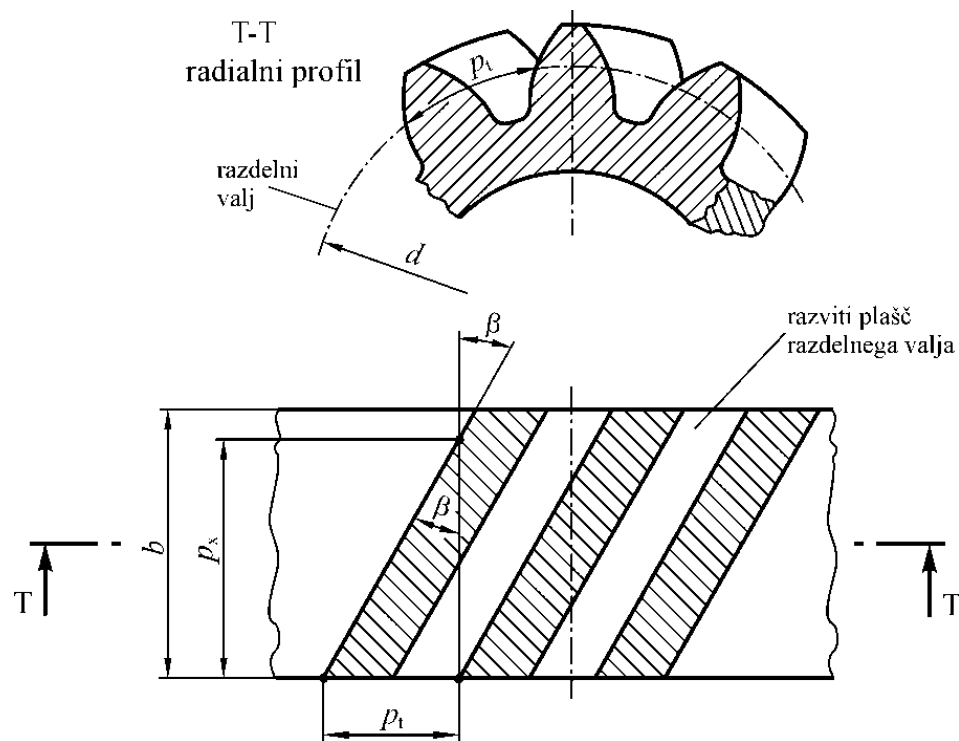



Zlom zoba in jamičenje zobnega boka

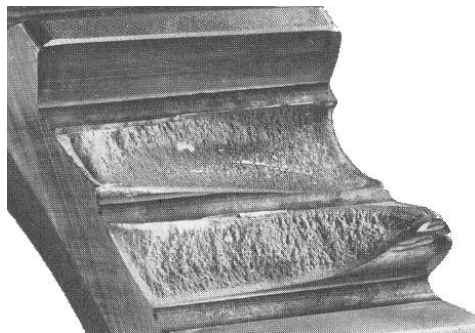

a)

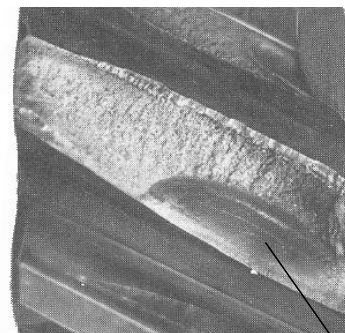

b)

utrujenostna
razpoka

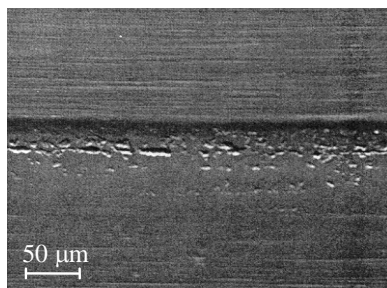

a)



b)



Razjedanje zobnega boka in obraba zobnega boka



a)

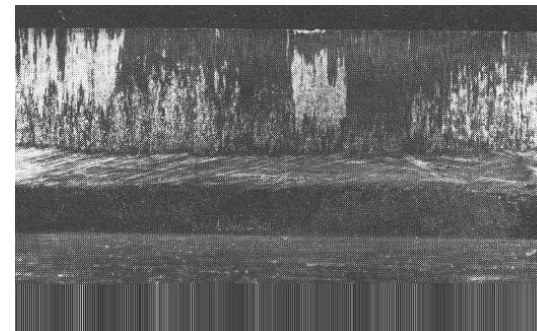

b)

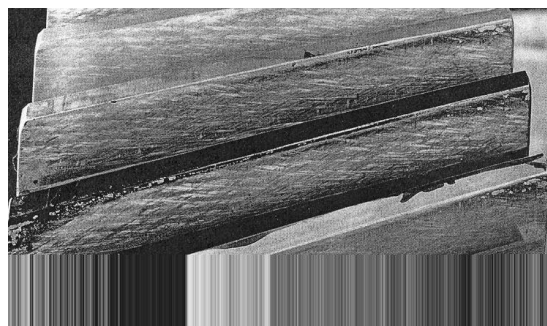

a)

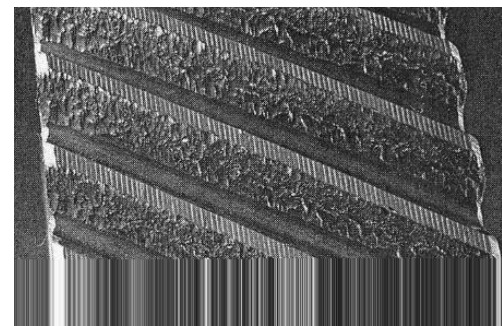

b)



Mejna območja najpogostejših poškodb zobniških dvojic

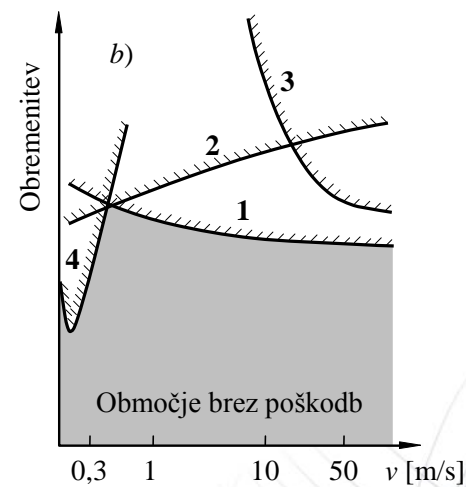
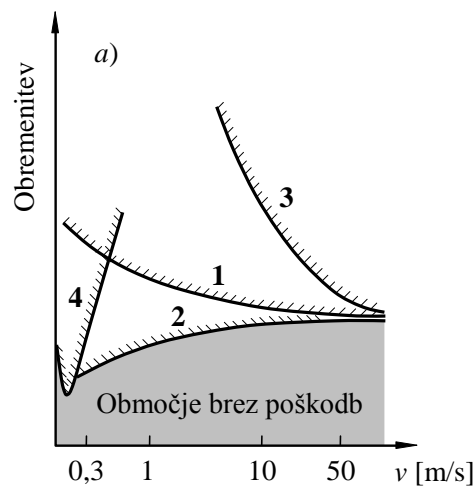

1- zlom zoba, 2- jamičenje, 3- toplotno razjedanje, 4- obraba